

# ASMT-QWBC-Nxxxx

Super 0.5W Cool White Power PLCC-4

Surface Mount LED Indicator



## Data Sheet



### Description

The Super 0.5W Cool White Power PLCC-4 SMT LED is Cool white mid-Power PLCC-4 SMT LEDs using InGaN chip technology. The package can be driven at high current due to its superior package design. The product is able to dissipate the heat more efficiently compared to the Power PLCC-4 SMT LEDs. These LEDs produce higher light output with better flux performance compared to the Power PLCC-4 SMT LED.

The Super 0.5W Cool White Power PLCC-4 SMT LEDs are designed for higher reliability, better performance, and operate under a wide range of environmental conditions. The performance characteristics of these new mid-power LEDs make them uniquely suitable for use in harsh conditions such as in automotive applications, and in electronics signs and signals.

To facilitate easy pick and place assembly, the LEDs are packed in EIA-compliant tape and reel. Every reel is shipped in single intensity and color bin, to provide close uniformity.

### Features

- Industry Standard PLCC 4 platform (3.2x2.8x1.9mm)
- High reliability package with enhanced silicone resin encapsulation
- High brightness with optimum flux performance using InGaN chip technologies
- Available in Cool White
- Available in 8mm carrier tape & 7 inch reel
- Low Thermal Resistance 40°C/W
- Wide viewing angle at 120 degree
- JEDEC MSL 2

### Applications

1. Interior automotive
  - a. Instrument panel backlighting
  - b. Central console backlighting
  - c. Navigation and audio system backlighting
  - d. Dome/Map lighting
  - e. Push button backlighting
  - f. Puddle lamp
  - g. Glove compartment illumination
2. Exterior automotive
  - a. Number plate illumination
3. Electronic signs and signals
  - a. Decorative lighting
4. Office automation, home appliances, industrial equipment
  - a. Panel/button backlighting
  - b. Display backlighting

**CAUTION:** ASMT-QWBC-Nxxxx LEDs are Class 2 ESD sensitive. Please observe appropriate precautions during handling and processing. Refer to Avago Application Note AN-1142 for additional details.

## Package Drawing

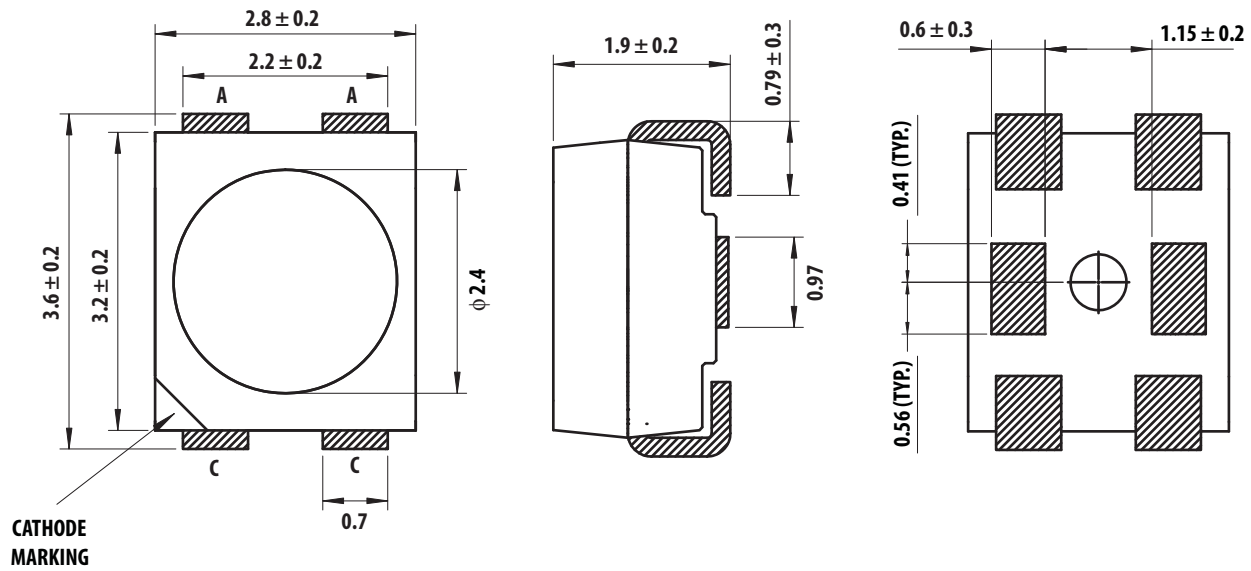

### Notes:

1. All Dimensions in millimeters.
2. Lead Polarity as shown in Figure 14.
3. Terminal Finish: Ag plating
4. Encapsulation material: Silicone resin

Figure 1. Package Drawing

Table 1. Device Selection Guide ( $T_j = 25^\circ\text{C}$ )

Color	Part Number	Luminous Flux, $\Phi_V^{[1]}$ (lm)			Test Current (mA)	Dice Technology
		Min. Flux (lm)	Typ. Flux (lm)	Max. Flux (lm)		
Cool White	ASMT-QWBC-NHJ0E	25.5	30.0	43.0	150	InGaN
	ASMT-QWBC-NJK0E	33.0	38.0	56.0	150	InGaN

### Notes:

1.  $\Phi_V$  is the total luminous flux output as measured with an integrating sphere at mono pulse conditions.
2. Tolerance =  $\pm 12\%$

## Part Numbering System

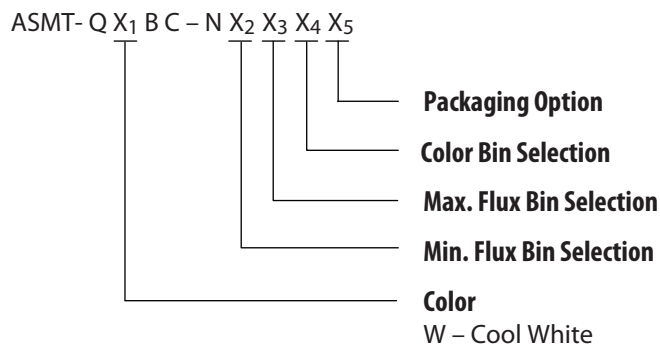

**Table 2. Absolute Maximum Ratings ( $T_A = 25^\circ\text{C}$ )**

Parameters	ASMT-QWBC-Nxxxx
DC Forward Current <sup>[1]</sup>	150 mA
Peak Forward Current <sup>[2]</sup>	300 mA
Power Dissipation	570 mW
Reverse Voltage, $V_R$ @ 10 $\mu\text{A}$	4
Junction Temperature	125°C
Operating Temperature	-40°C to +120°C
Storage Temperature	-40°C to +120°C

Notes:

1. Derate Linearly as shown in Figure 6.
2. Duty Factor = 10%, Frequency = 1kHz

**Table 3. Optical Characteristics ( $T_J = 25^\circ\text{C}$ )**

Color	Part Number	Dice Technology	Typical Chromaticity Coordinates		Viewing Angle $2\theta_{1/2}$ <sup>[1]</sup> (Degrees)	Luminous Efficiency $\eta_e$ (lm/W)	Total Flux / Luminous Intensity $\Phi_V$ (lm) / $I_V$ (cd)
			x	y	Typ.	Typ.	Typ.
Cool White	ASMT-QWBC-Nxxxx	InGaN	0.31	0.31	120	59	2.50

Notes:

1.  $\theta_{1/2}$  is the off-axis angle where the luminous intensity is  $1/2$  the peak intensity.

**Table 4. Electrical Characteristics ( $T_J = 25^\circ\text{C}$ )**

Part Number	Forward Voltage $V_F$ (Volts) @ $I_F = 150$ mA		Thermal Resistance $R\theta_{J,p}$ ( $^\circ\text{C}/\text{W}$ )
	Typ.	Max.	
ASMT-QWBC-NxxxE	3.4	3.8	40

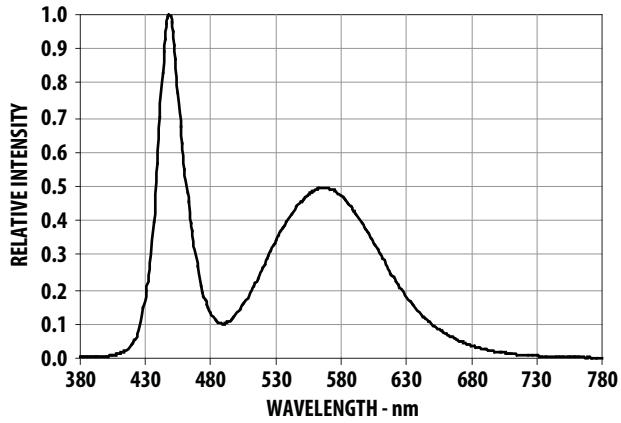

Figure 2. Relative Intensity Vs. Wavelength

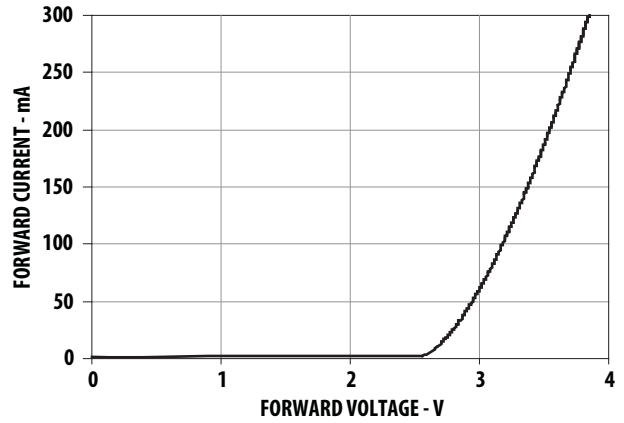

Figure 3. Forward Current Vs. Forward Voltage.

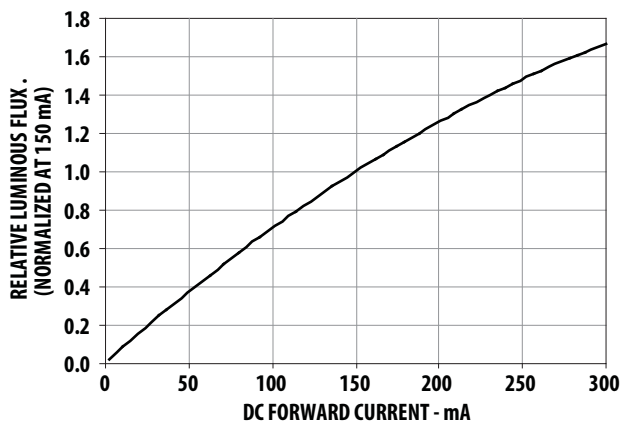

Figure 4. Relative Flux vs. Forward Current

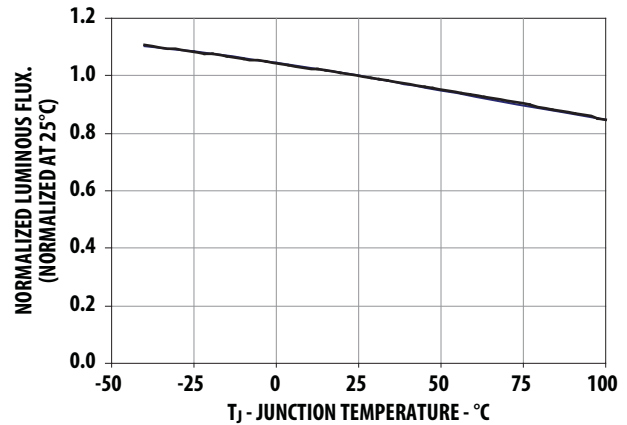

Figure 5. Relative Flux Vs. Temperature

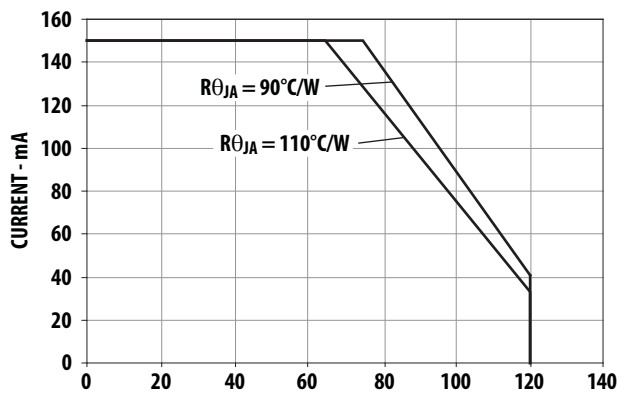

Figure 6a. Maximum Forward Current Vs. Ambient Temperature. Derated Based on  $T_{JMAX} = 125^{\circ}C$ ,  $R\theta_{JA} = 110^{\circ}C/W$  &  $90^{\circ}C/W$ .

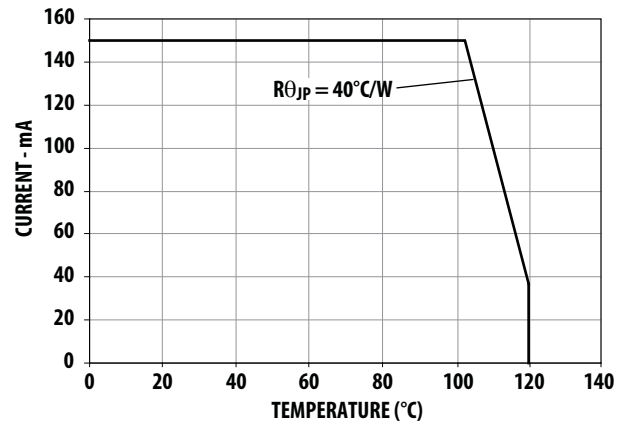

Figure 6b. Maximum Forward Current Vs. Solder Point Temperature. Derated Based on  $T_{JMAX} = 125^{\circ}C$ ,  $R\theta_{JP} = 40^{\circ}C/W$ .

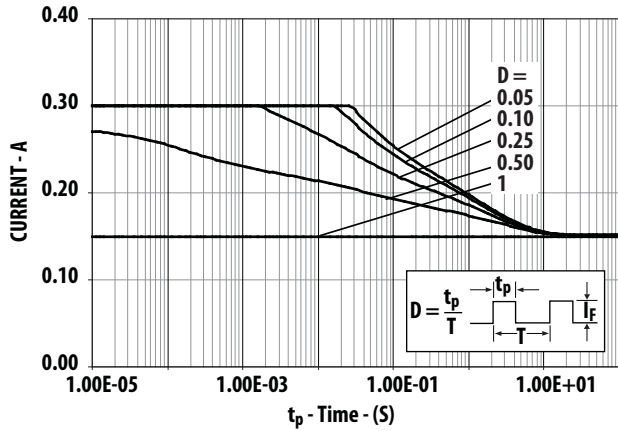

Figure 7a. Maximum Pulse Current Vs. Ambient Temperature. Derated Based on  $T_A = 25^\circ\text{C}$ ,  $R_{\theta J-A} = 110^\circ\text{C/W}$ .

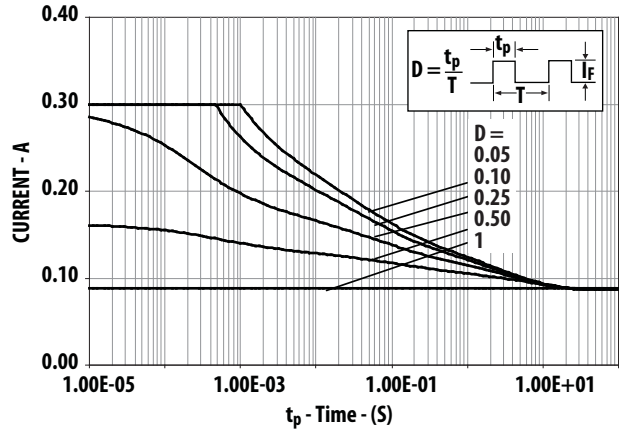

Figure 7b. Maximum Pulse Current Vs. Ambient Temperature. Derated Based on  $T_A = 85^\circ\text{C}$ ,  $R_{\theta J-A} = 110^\circ\text{C/W}$ .

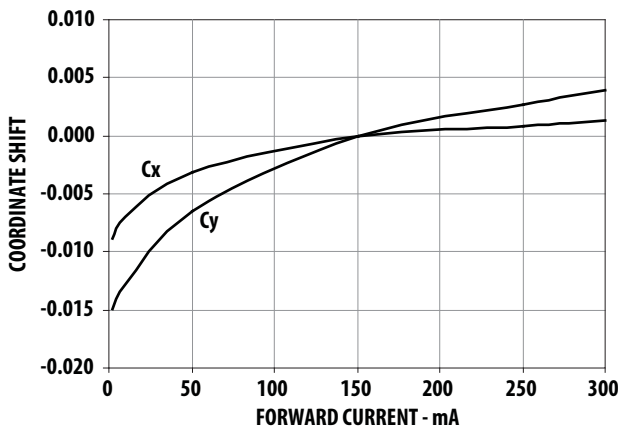

Figure 8. Chromaticity Shift Vs. Forward Current

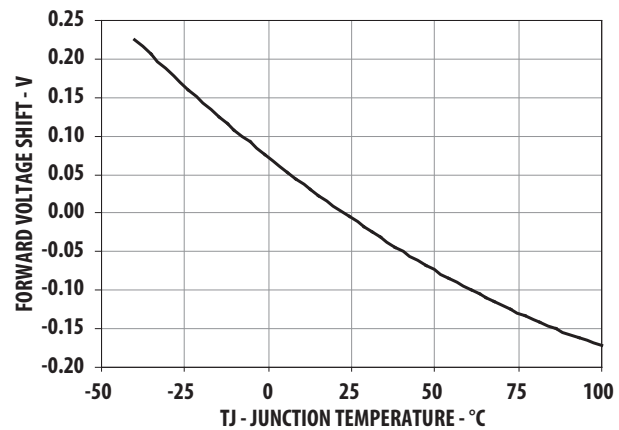

Figure 9. Forward Voltage Shift Vs. Temperature.

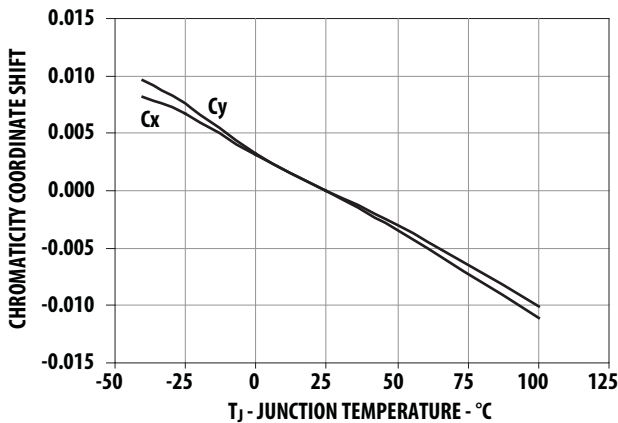

Figure 10. Chromaticity Shift Vs. Temperature

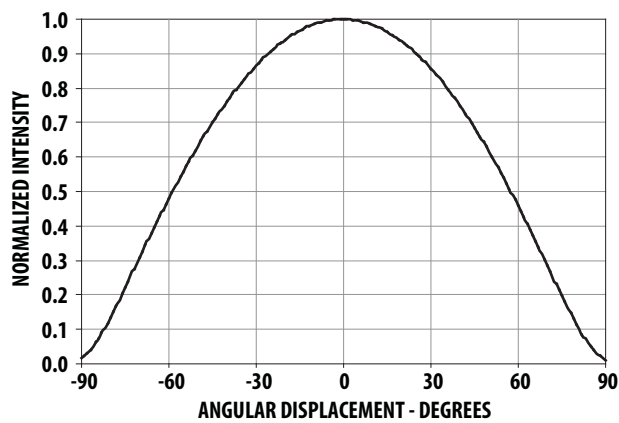
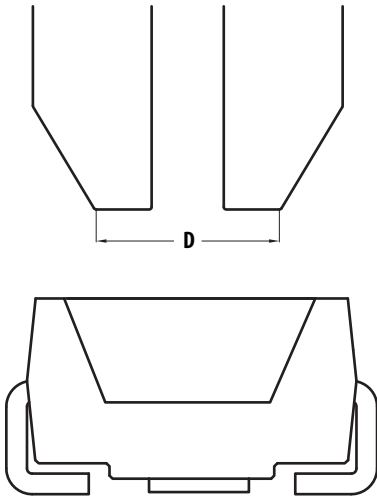
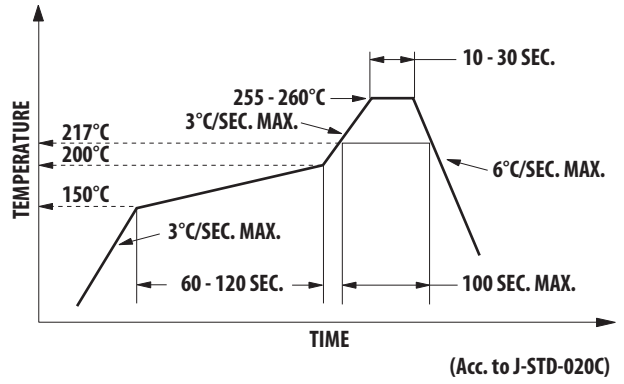

Figure 11. Radiation Pattern



Note: Diameter "D" should be smaller than 2.2mm

Figure 12. Recommended Pick and Place Nozzle Size



Note: For detail information on reflow soldering of Avago surface mount LEDs, do refer to Avago Application Note AN 1060 Surface Mounting SMT LED Indicator Components.

Figure 13. Recommended Pb-free Reflow Soldering Profile

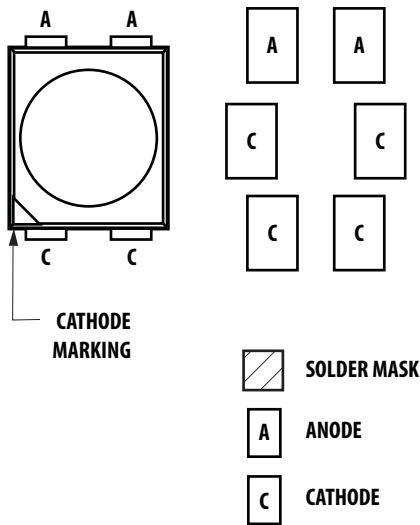
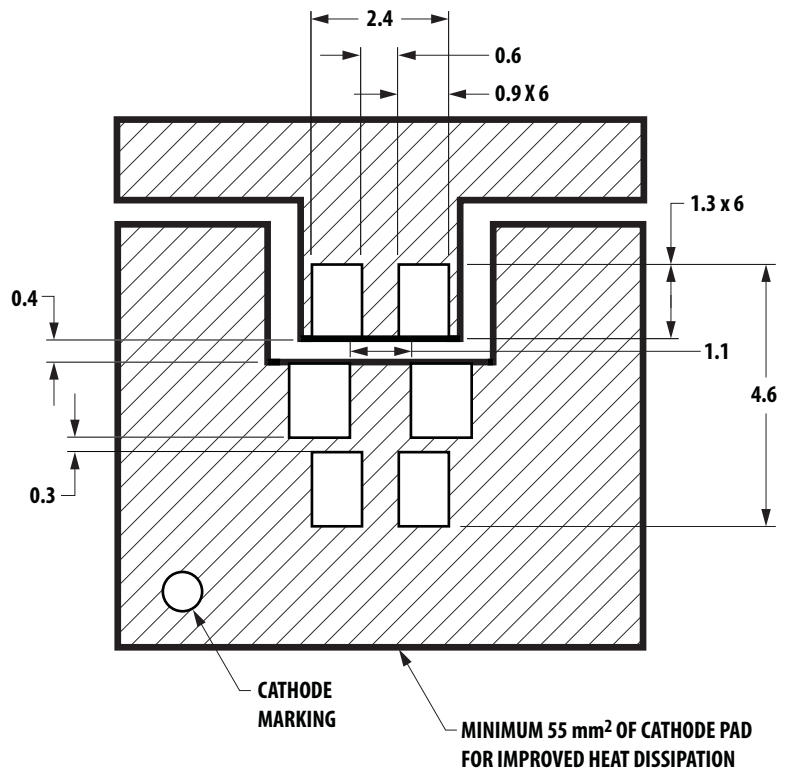

Figure 14. Recommended Soldering Pad Pattern



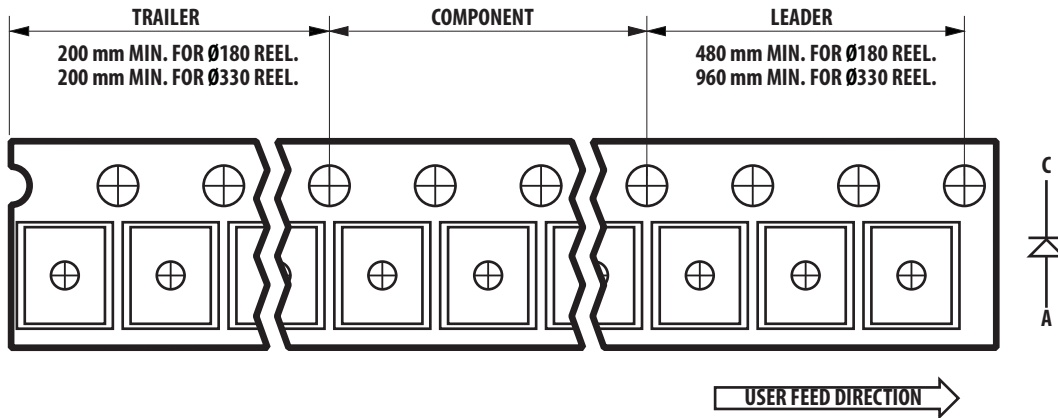

Figure 15. Tape Leader and Trailer Dimensions

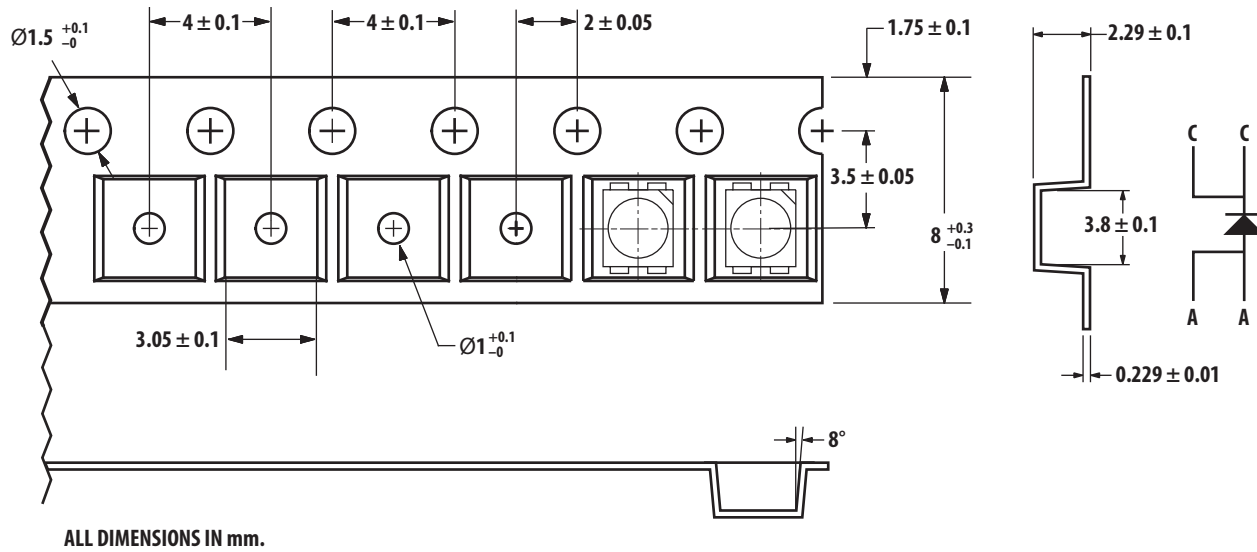

Figure 16. Tape Dimensions

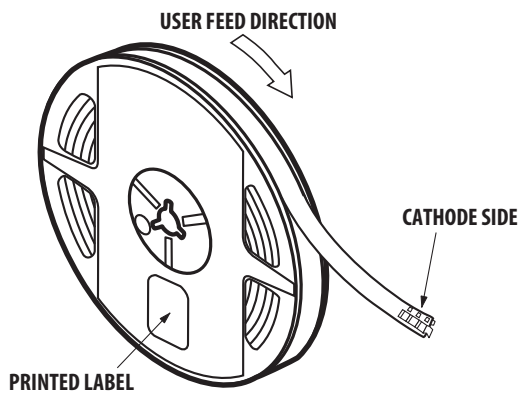

Figure 17. Reeling Orientation

## Handling Precaution

The encapsulation material of the product is made of silicone for better reliability of the product. As silicone is a soft material, please do not press on the silicone or poke a sharp object onto the silicone. These might damage the product and cause premature failure. During assembly or handling, the unit should be held on the body only. Please refer to Avago Application Note AN 5288 for detail information.

## Moisture Sensitivity

This product is qualified as Moisture Sensitive Level 2 per Jedec J-STD-020. Precautions when handling this moisture sensitive product is important to ensure the reliability of the product. Do refer to Avago Application Note AN5305 Handling of Moisture Sensitive Surface Mount Devices for details.

### A. Storage before use

- Unopen moisture barrier bag (MBB) can be stored at <40°C/90%RH for 12 months. If the actual shelf life has exceeded 12 months and the HIC indicates that baking is not required, then it is safe to reflow the LEDs per the original MSL rating.
- It is not recommended to open the MBB prior to assembly (e.g. for IQC).

### B. Control after opening the MBB

- The humidity indicator card (HIC) shall be read immediately upon opening of MBB.
- The LEDs must be kept at <30°C / 60%RH at all time and all high temperature related process including soldering, curing or rework need to be completed within 1 year.

### C. Control for unfinished reel

- For any unuse LEDs, they need to be stored in sealed MBB with desiccant or desiccator at <5%RH.

### D. Control of assembly boards

- If the PCB soldered with the LEDs is to be subjected to other high temperature processes, the PCB need to be stored in sealed MBB with desiccant or desiccator at <5%RH to ensure no LEDs have exceeded their floor life of 1 year.

### E. Baking is required if

- “60%” HIC indicator is NOT Green.
- The LEDs are exposed to condition of >30°C/60% RH at any time.
- The LEDs floor life exceeded 1 year.

Recommended baking condition: 60±5°C for 20 hours.

## Device Color (X<sub>1</sub>)

W	Cool White
---	------------

## Flux Bin Select (X<sub>2</sub>X<sub>3</sub>)

Individual reel will contain parts from one bin only

X <sub>2</sub>	Min Flux Bin
X <sub>3</sub>	Max Flux Bin

## Flux Bin Limits

Bin ID	Min. (lm)	Max. (lm)
0	3.40	4.30
A	4.30	5.50
B	5.50	7.00
C	7.00	9.00
D	9.00	11.50
E	11.50	15.00
F	15.00	19.50
G	19.50	25.50
H	25.50	33.00
J	33.00	43.00
K	43.00	56.00
L	56.00	73.00

Tolerance of each bin limit = ± 12%

## Color Bin Select (X<sub>4</sub>)

Individual reel will contain parts from one sub bin only.

X <sub>4</sub>	Full Distribution
0	
A	5K and 5L only
B	6K and 6L only
C	7K and 7L only
D	8K and 8L only
E	5K and 6K only
F	5L and 6L only
G	6K and 7K only
H	6L and 7L only
J	7K and 8K only
K	7L and 8L only
L	5K, 5L, 6K and 6L only
M	6K, 6L, 7K and 7L only
N	7K, 7L, 8K and 8L only
Z	Special binning



### Color Bin Limits

Bin ID	Sub Bin ID	Limits (Chromaticity Coordinates)				
5K	5Ka	x	0.296	0.304	0.302	0.294
		y	0.259	0.270	0.276	0.264
	5Kb	x	0.294	0.302	0.300	0.291
		y	0.264	0.276	0.281	0.268
	5Kc	x	0.304	0.313	0.312	0.302
		y	0.270	0.284	0.291	0.276
	5Kd	x	0.302	0.312	0.310	0.300
		y	0.276	0.291	0.297	0.281
5L	5La	x	0.291	0.300	0.298	0.288
		y	0.268	0.281	0.288	0.274
	5Lb	x	0.288	0.298	0.295	0.285
		y	0.274	0.288	0.294	0.279
	5Lc	x	0.300	0.310	0.309	0.298
		y	0.281	0.297	0.305	0.288
	5Ld	x	0.298	0.309	0.307	0.295
		y	0.288	0.305	0.312	0.294
6K	6Ka	x	0.313	0.322	0.321	0.312
		y	0.284	0.297	0.305	0.291
	6Kb	x	0.312	0.321	0.320	0.310
		y	0.291	0.305	0.314	0.297
	6Kc	x	0.322	0.330	0.330	0.321
		y	0.297	0.310	0.320	0.305
	6Kd	x	0.321	0.330	0.330	0.320
		y	0.305	0.320	0.330	0.314
6L	6La	x	0.310	0.320	0.319	0.309
		y	0.297	0.314	0.322	0.305
	6Lb	x	0.309	0.319	0.318	0.307
		y	0.305	0.322	0.329	0.312
	6Lc	x	0.320	0.330	0.330	0.319
		y	0.314	0.330	0.339	0.322
	6Ld	x	0.319	0.330	0.330	0.318
		y	0.322	0.339	0.347	0.329

Bin ID	Sub Bin ID	Limits (Chromaticity Coordinates)				
7K	7Ka	x	0.330	0.336	0.337	0.330
		y	0.310	0.320	0.330	0.320
	7Kb	x	0.330	0.337	0.337	0.330
		y	0.320	0.330	0.341	0.330
	7Kc	x	0.336	0.343	0.344	0.337
		y	0.320	0.331	0.341	0.330
	7Kd	x	0.337	0.344	0.345	0.337
		y	0.330	0.341	0.352	0.341
7L	7La	x	0.330	0.337	0.337	0.330
		y	0.330	0.341	0.349	0.339
	7Lb	x	0.330	0.337	0.338	0.330
		y	0.339	0.349	0.358	0.347
	7Lc	x	0.337	0.345	0.346	0.337
		y	0.341	0.352	0.362	0.349
	7Ld	x	0.337	0.346	0.347	0.338
		y	0.349	0.362	0.371	0.358
8K	8Ka	x	0.343	0.351	0.352	0.344
		y	0.331	0.343	0.354	0.341
	8Kb	x	0.344	0.352	0.354	0.345
		y	0.341	0.354	0.364	0.352
	8Kc	x	0.351	0.360	0.362	0.352
		y	0.343	0.357	0.369	0.354
	8Kd	x	0.352	0.362	0.364	0.354
		y	0.354	0.369	0.380	0.364
8L	8La	x	0.345	0.354	0.355	0.346
		y	0.352	0.364	0.375	0.362
	8Lb	x	0.346	0.355	0.356	0.347
		y	0.362	0.375	0.385	0.371
	8Lc	x	0.354	0.364	0.366	0.355
		y	0.364	0.380	0.391	0.375
	8Ld	x	0.355	0.366	0.367	0.356
		y	0.375	0.391	0.401	0.385

Tolerance of each bin limit =  $\pm 0.02$ .

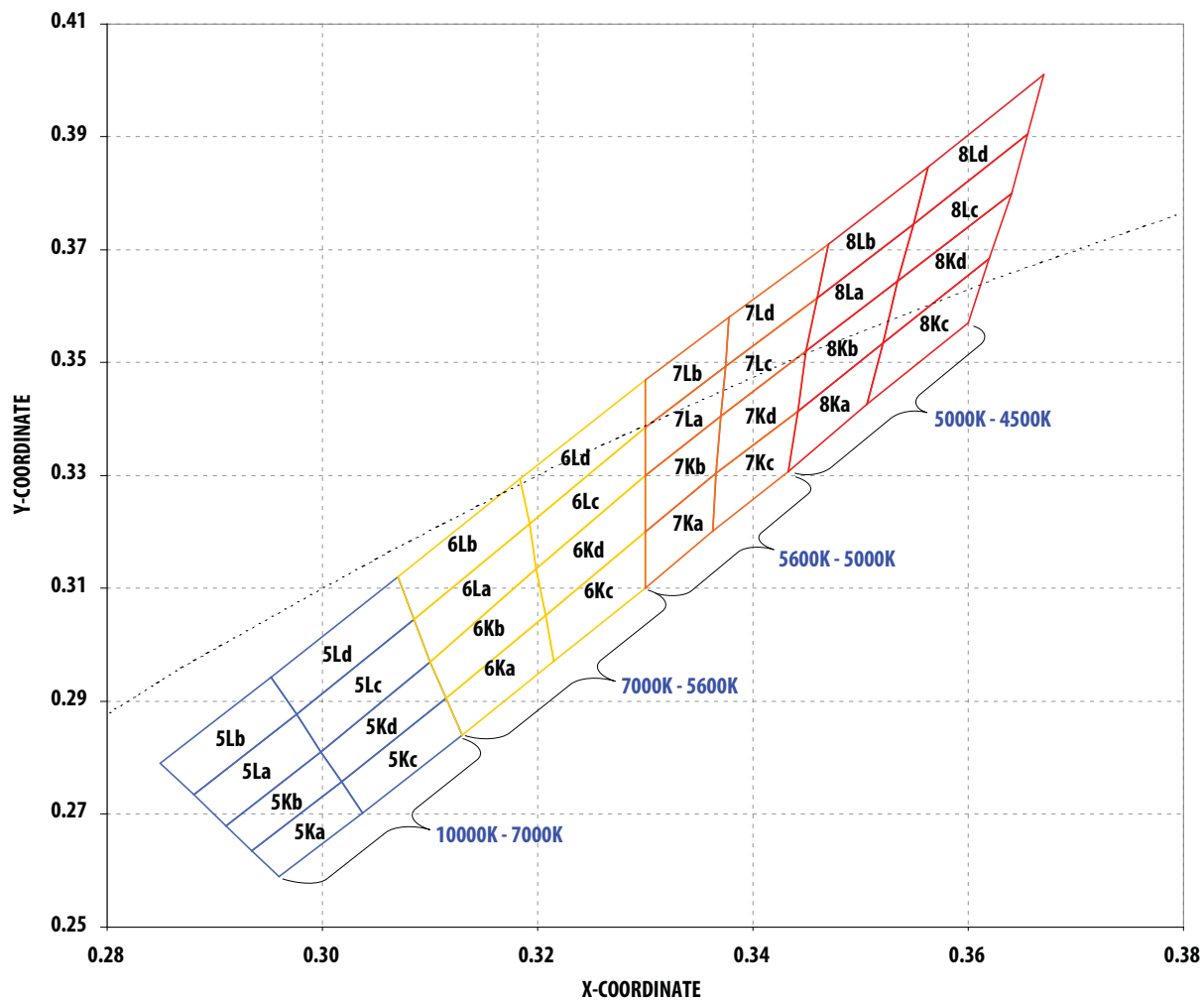

### V<sub>F</sub> Bin Limits

Bin ID	Min.	Max.
S4	2.90	3.20
S5	3.20	3.50
S6	3.50	3.80

Tolerance of each bin limit = ±0.1V

### Packaging Option (X<sub>5</sub>)

Option	Test Current	Package Type	Reel Size
E	150mA	Top Mount	7 Inch

For product information and a complete list of distributors, please go to our web site: [www.avagotech.com](http://www.avagotech.com)

Avago, Avago Technologies, and the A logo are trademarks of Avago Technologies in the United States and other countries. Data subject to change. Copyright © 2005-2010 Avago Technologies. All rights reserved. AV02-1744EN - April 6, 2010

